

AVALON BLOCK

MOE - NATIONWIDE FLS
AUCKLAND, WELLINGTON AND
CHRISTCHURCH



aurecon

www.aurecongroup.com
ABN: 54 005 139 873

A person using the Aurecon drawings and other data accepts the risk of:
1. Using the drawings and other data in electronic form without requesting and checking them for accuracy against the original hard copy versions;
2. Using the drawing or other data for any purpose not agreed to in writing by Aurecon.
Wherever a discrepancy in the contract documents is found and unless directed otherwise by the Principal/Engineer, the contractor shall adopt, at their own cost the greater quantum, class of finish, grade, or specification where applicable.

**INFORMATION ONLY
NOT FOR CONSTRUCTION**

SIZE	DATE	DRAWING No.	PROJECT No.	WBS	TYPE	DISC - NUMBER	REV
A1	20/10/15	246313	AVAL	DRG	S00-00	A	

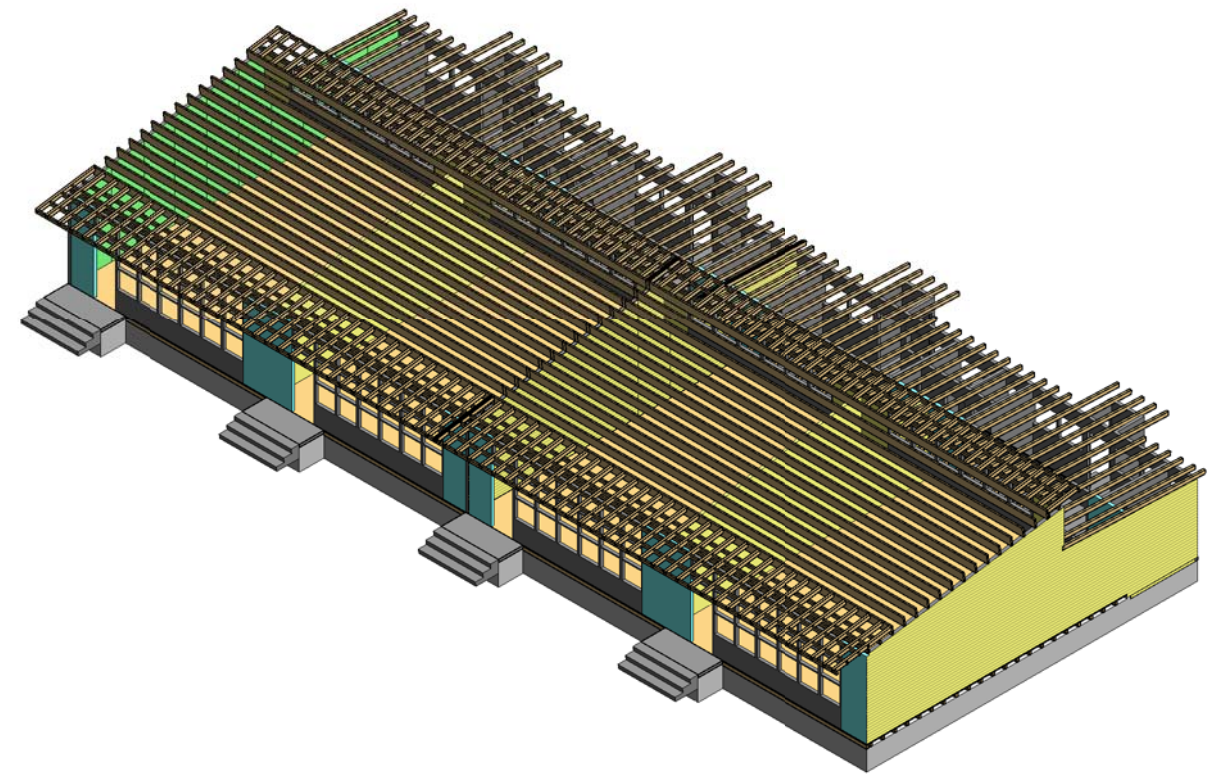

3D VIEW



NOTES:

THESE STRUCTURAL DESIGN METHODOLOGIES HAVE BEEN DEVELOPED BASED ON SET ARCHITECTURAL ALTERATIONS AS WELL AS A NUMBER OF ASSUMPTIONS IN REGARDS TO THE LOCATION AND EXISTING DETAILS OF THE BUILDING. THE SUITABILITY OF THESE STRUCTURAL SCHEMES FOR APPLICATION TO ANY SPECIFIC BUILDING SHOULD BE ASSESSED BY A SUITABLY QUALIFIED ENGINEER PRIOR TO IMPLEMENTATION. A BUILDING CONSENT WILL BE REQUIRED BEFORE CARRYING OUT ANY ALTERATIONS

File Path: C:\Users\jfinnegan\Documents\246313\AVALON BLOCK-CENTRAL ELEC.DWG, 20/10/15, www.aurecon.co.nz

REV	DATE	REVISION DETAILS	APPROVAL
A	20/10/15	FOR INFORMATION	J.FINNEGAN

SCALE	SIZE
1:1	A1
DRAWN	
W.E.NICHOLSON	
DESIGNED	
P.DON	
CHECKED	
C.HECKMANN	

INFORMATION ONLY NOT FOR CONSTRUCTION	
APPROVED	DATE
J.FINNEGAN	20/10/15
J.FINNEGAN	

PROJECT	MOE - NATIONWIDE FLS AUCKLAND, WELLINGTON AND CHRISTCHURCH	
TITLE	AVALON BLOCK SESMIC STRENGTHENING GENERAL 3D AND PHOTOS	
DRAWING No.	246313	REV A
PROJECT No.	WBS	TYPE
246313	AVAIL	DRG
DISC - NUMBER	S00-01	

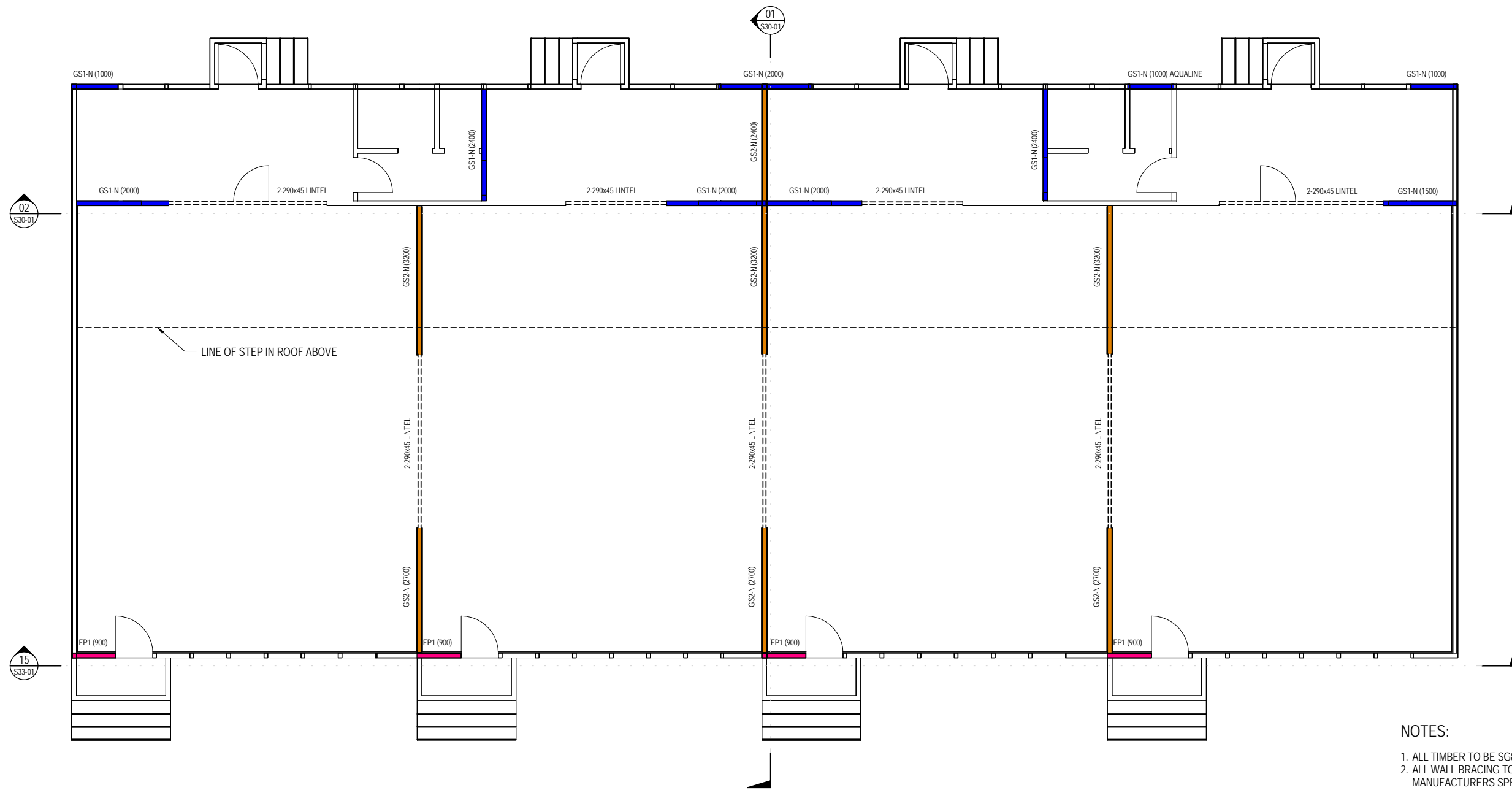

FLOOR PLAN OPTION 1
1 : 50

- NOTES:
1. ALL TIMBER TO BE SG8 GRADE.
 2. ALL WALL BRACING TO BE INSTALLED TO MANUFACTURERS SPECIFICATION. THIS INCLUDES PERIMETER SHEET FIXINGS AND WALL END HOLD DOWNS.
 3. ALL STEELWORK SHALL BE CLEANED AND THEN PRIMED WITH ONE COAT OF APPROVED RED OXIDE ZINC PHOSPHATE ALKYD PRIMER TO ACHIEVE A MINIMUM DRY FILM THICKNESS OF 75 MICRONS.
 4. NEW WALLS NOT LABELED AS SPECIFIC BRACING WALLS SHALL BE LINED WITH STANDARD PLASTERBOARD LININGS (BOTH SIDES FOR INTERNAL WALLS. 1 SIDE FOR EXTERNAL WALLS)
 5. SEE S48-01 FOR TYPICAL LINTEL FIXING AND BRACING WALL HOLD DOWN DETAILS.
 6. REFER TO DESIGN FEATURES REPORT FOR DESCRIPTION OF THE STRUCTURAL SCHEME, LOADING PARAMETERS AND %NBS TARGET VALUES.

File Path: 20120116.13.17.10.n. Office: E:\projec\C\Users\jshayn_4444\Documents\Documents\246313.AVALON_BLOCK-CENTRAL_FLOOR PLAN_OPTION 1.rvt



REV	DATE	REVISION DETAILS	APPROVAL
A	20/10/15	FOR INFORMATION	J.FINNEGAN

SCALE	SIZE
As indicated	A1
DRAWN W.E.NICHOLSON	
DESIGNED P.DON	
CHECKED C.HECKMANN	

INFORMATION ONLY NOT FOR CONSTRUCTION	
APPROVED	DATE 20/10/15
J.FINNEGAN	
J.FINNEGAN	

PROJECT	TITLE	DRAWING No.	PROJECT No.	WBS	TYPE	DISC - NUMBER	REV
MOE - NATIONWIDE FLS AUCKLAND, WELLINGTON AND CHRISTCHURCH	AVALON BLOCK OPTION 1 AUCKLAND, CHRISTCHURCH	246313	246313	AVAIL	DRG	S25-01	A

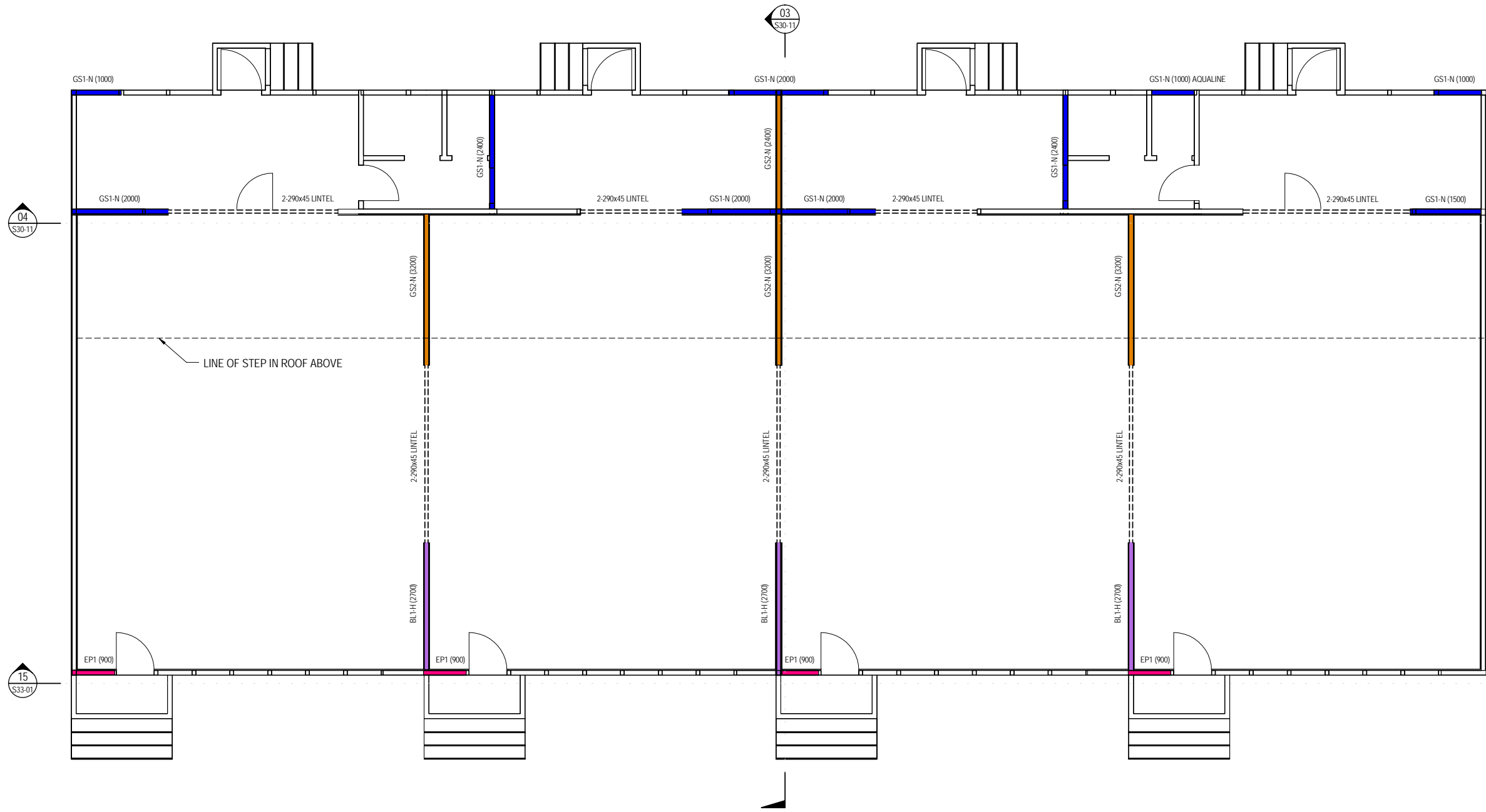

FLOOR PLAN OPTION 1
1:50

NOTES:

1. ALL TIMBER TO BE SG8 GRADE.
2. ALL WALL BRACING TO BE INSTALLED TO MANUFACTURERS SPECIFICATION. THIS INCLUDES PERIMETER SHEET FIXINGS AND WALL END HOLD DOWNS.
3. ALL STEELWORK SHALL BE CLEANED AND THEN PRIMED WITH ONE COAT OF APPROVED RED OXIDE ZINC PHOSPHATE ALKYD PRIMER TO ACHIEVE A MINIMUM DRY FILM THICKNESS OF 75 MICRONS.
4. NEW WALLS NOT LABELED AS SPECIFIC BRACING WALLS SHALL BE LINED WITH STANDARD PLASTERBOARD LININGS (BOTH SIDES FOR INTERNAL WALLS. 1 SIDE FOR EXTERNAL WALLS)
5. SEE S48-01 FOR TYPICAL LINTEL FIXING AND BRACING WALL HOLD DOWN DETAILS.
6. REFER TO DESIGN FEATURES REPORT FOR DESCRIPTION OF THE STRUCTURAL SCHEME, LOADING PARAMETERS AND %NBS TARGET VALUES.

File Path: C:\Users\jfinnegan\Documents\246313_AVALON_BLOCK_CENTRAL_FLS\2015_08_10_15_01.dwg



REV	DATE	REVISION DETAILS	APPROVAL
A	20/10/15	FOR INFORMATION	J.FINNEGAN

SCALE	SIZE
As indicated	A1
DRAWN	
W.E.NICHOLSON	
DESIGNED	
P.DON	
CHECKED	
C.HECKMANN	

INFORMATION ONLY	APPROVED
NOT FOR CONSTRUCTION	
	DATE 20/10/15
	J.FINNEGAN
	J.FINNEGAN

PROJECT	TITLE	DRAWING No.	PROJECT No.	WBS	TYPE	DISC - NUMBER	REV
MOE - NATIONWIDE FLS AUCKLAND, WELLINGTON AND CHRISTCHURCH	AVALON BLOCK OPTION 1 WELLINGTON	246313	246313	AVAIL	DRG	S25-11	A

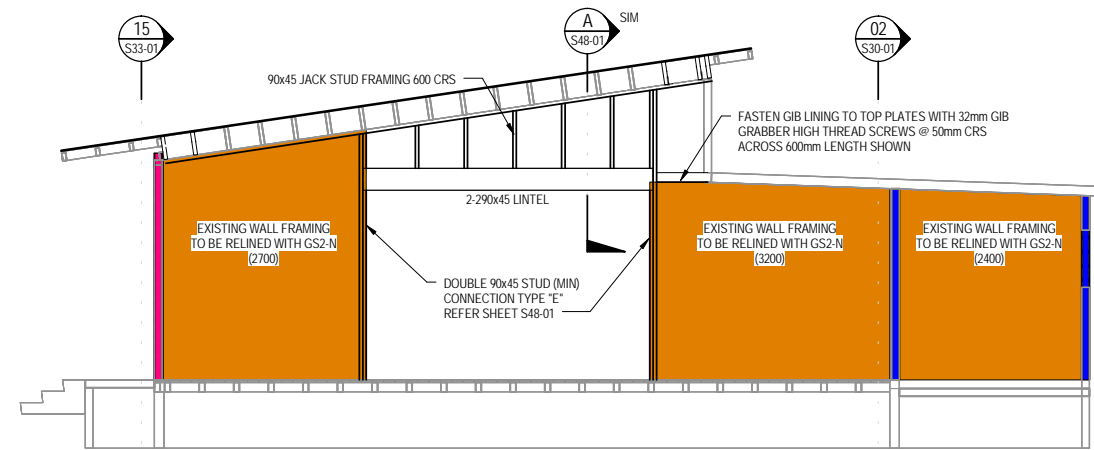

SECTION 01
1 : 50

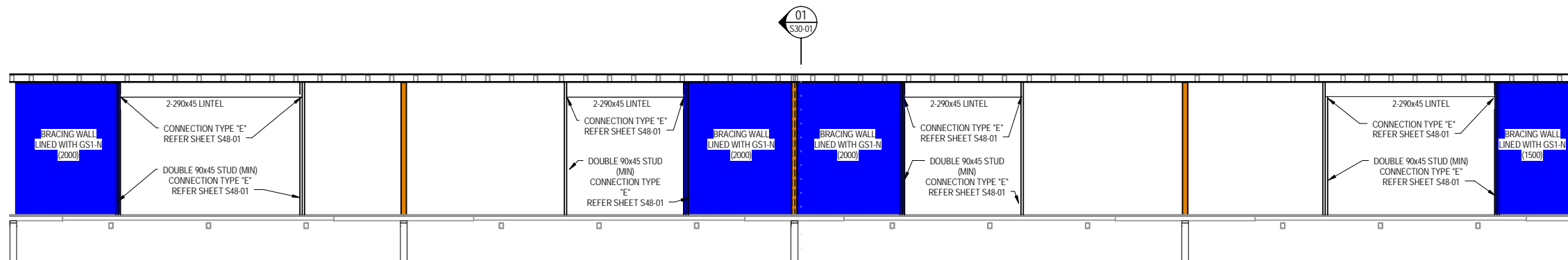

SECTION 02
1 : 50

File Path: 20120115.16.37.18.n... Office: E:\projec... \C:\Users\j... \Documents\Documents\240312\AVALON_BLOCK-CENTRAL_ELEC.DWG - 2015-09-08 10:04:04

REV	DATE	REVISION DETAILS	APPROVAL
A	20/10/15	FOR INFORMATION	J.FINNEGAN

SCALE	SIZE
1 : 50	A1
DRAWN W.E.NICHOLSON	
DESIGNED P.DON	
CHECKED C.HECKMANN	

INFORMATION ONLY NOT FOR CONSTRUCTION	
APPROVED	DATE 20/10/15
J.FINNEGAN	
J.FINNEGAN	

PROJECT	TITLE	DRAWING No.	PROJECT No.	WBS	TYPE	DISC - NUMBER	REV
MOE - NATIONWIDE FLS AUCKLAND, WELLINGTON AND CHRISTCHURCH	AVALON BLOCK OPTION 1 AUCKLAND, CHRISTCHURCH	246313	246313	AVAL	DRG	S30-01	A

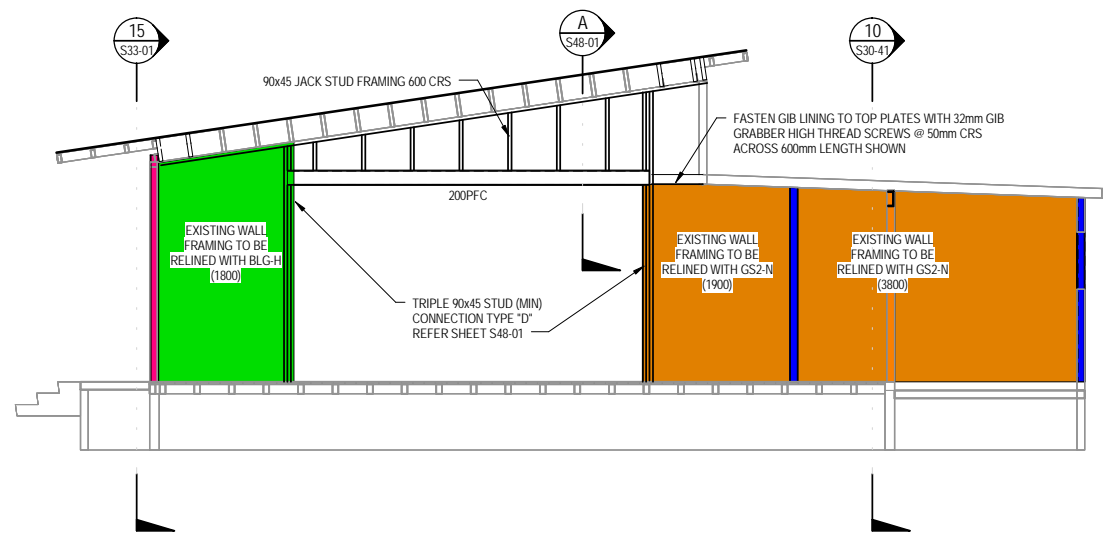

SECTION 09
1 : 50

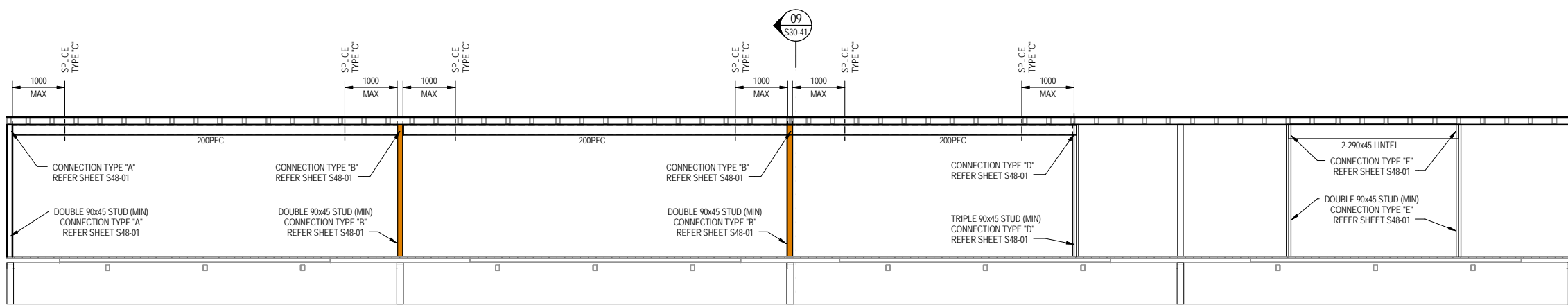

SECTION 10
1 : 50

File Path: C:\Users\jfinnegan\Documents\246313\AVALON\BLOC-CENTRAL_ELEC.DWG; Date: 20/10/15 15:37:33; n. 0/0/0



CLIENT

MINISTRY OF EDUCATION
Te Tāhuhu o te Mātauranga

REV	DATE	REVISION DETAILS	APPROVAL
A	20/10/15	FOR INFORMATION	J.FINNEGAN

SCALE	SIZE
1 : 50	A1
DRAWN	
W.E.NICHOLSON	
DESIGNED	
P.DON	
CHECKED	
C.HECKMANN	

INFORMATION ONLY
NOT FOR CONSTRUCTION

APPROVED

J.FINNEGAN
DATE 20/10/15
J.FINNEGAN

PROJECT	TITLE	DRAWING No.	PROJECT No.	WBS	TYPE	DISC - NUMBER	REV
MOE - NATIONWIDE FLS AUCKLAND, WELLINGTON AND CHRISTCHURCH	AVALON BLOCK OPTION 2 WELLINGTON	246313	246313	AVAIL	DRG	S30-41	A

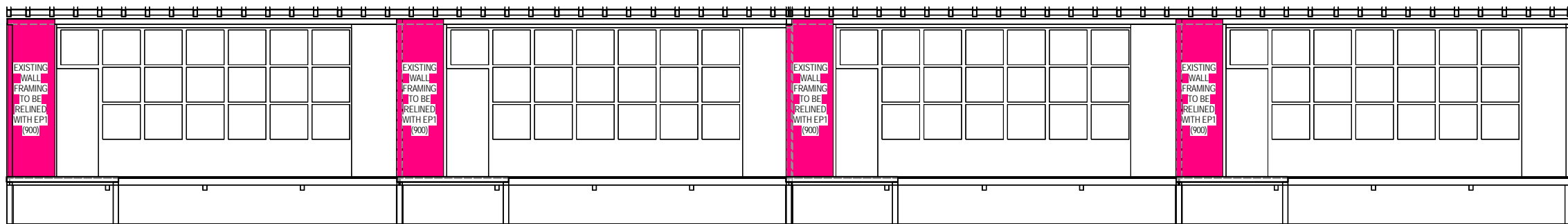

SECTION 15
1 : 50

File Path: 2010210115.07.25.n. Office: E:\eproc\C\Users\jhepp\Documents\Documents\40312\MOE-AVALON-BLOCK-CENTRAL-ELEV.DWG User: jhepp



REV	DATE	REVISION DETAILS	APPROVAL
A	20/10/15	FOR INFORMATION	J.FINNEGAN

SCALE	SIZE
1 : 50	A1
DRAWN	
W.E.NICHOLSON	
DESIGNED	
P.DON	
CHECKED	
C. HECKMANN	

INFORMATION ONLY
NOT FOR CONSTRUCTION
APPROVED
J.FINNEGAN
J.FINNEGAN

PROJECT	MOE - NATIONWIDE FLS AUCKLAND, WELLINGTON AND CHRISTCHURCH AVALON BLOCK			
TITLE	TYPICAL ELEVATION			
DRAWING No.	PROJECT No.	WBS	TYPE	DISC - NUMBER
246313	-	AVAL	-	DRG -
				S33-01
				REV
				A

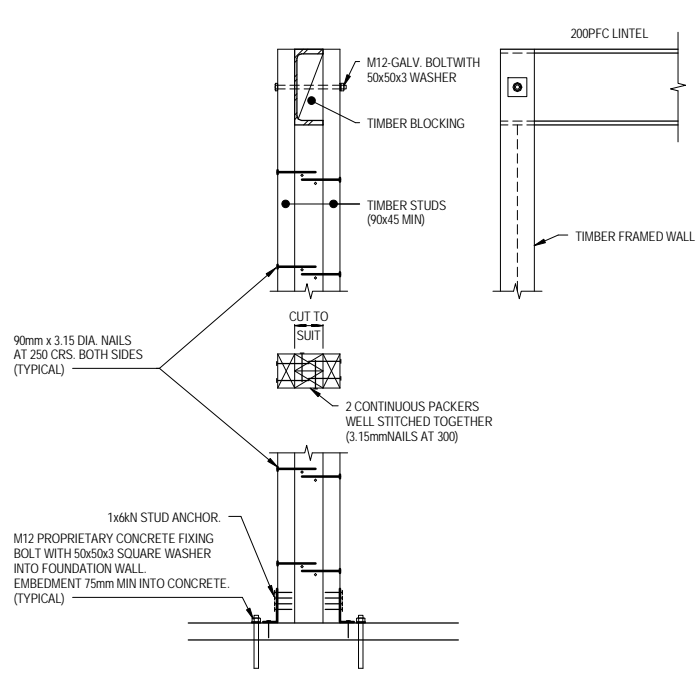

PFC LINTEL/TIMBER WALL FRAMING CONNECTION (TYPE "A")

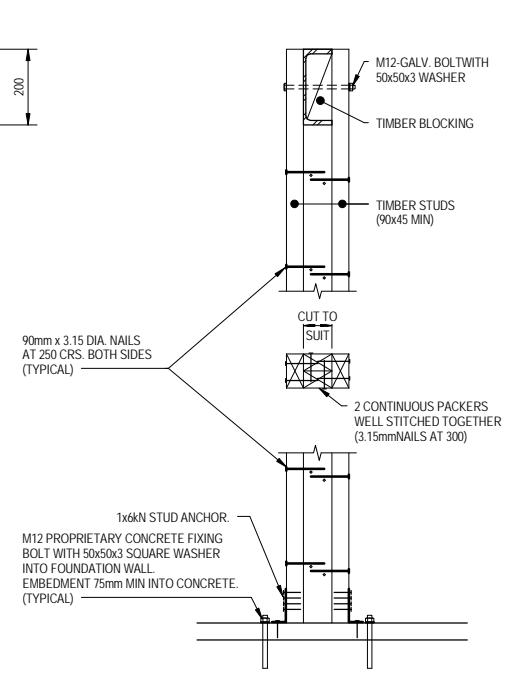

PFC CONTINUOUS THROUGH TIMBER WALL FRAMING CONNECTION (TYPE "B")

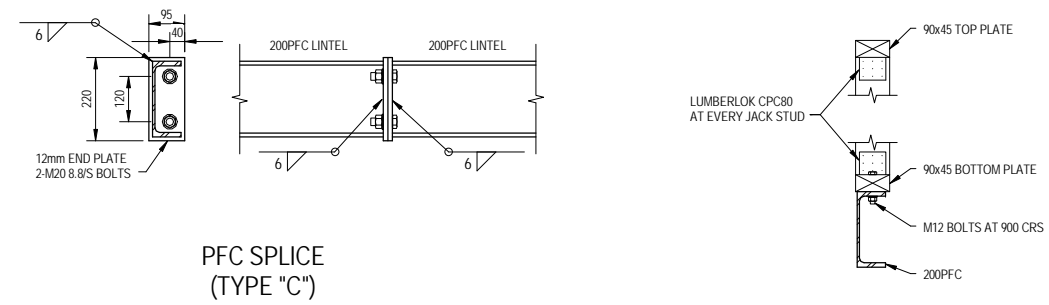
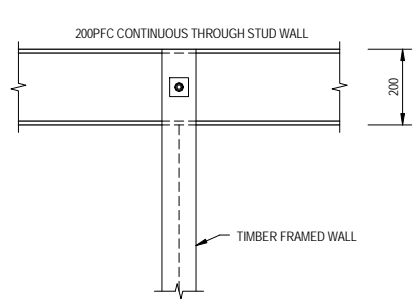

PFC SPLICE (TYPE "C")

SECTION A
1:10
S30-01

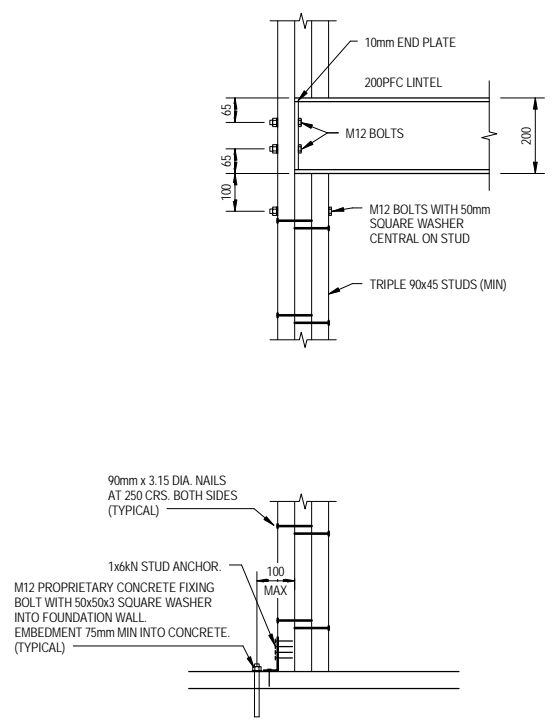

PFC LINTEL/TIMBER WALL FRAMING CONNECTION (TYPE "D")

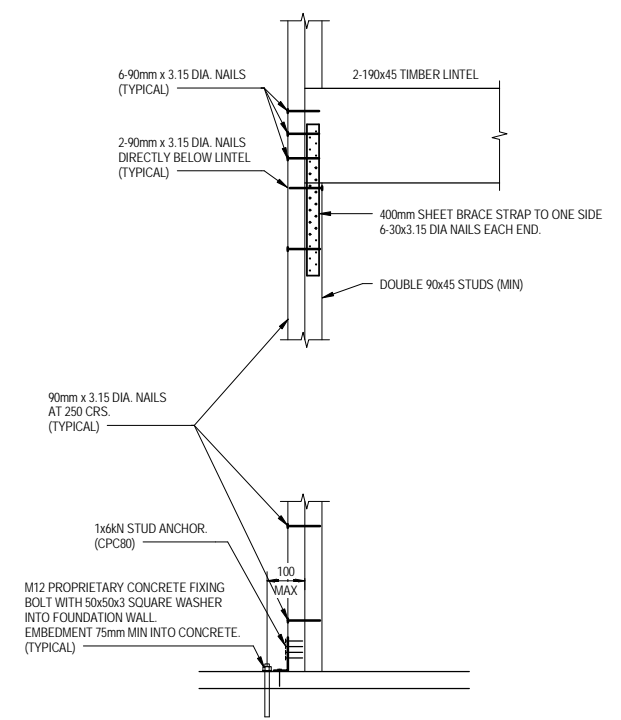

TIMBER LINTEL/TIMBER WALL FRAMING CONNECTION (TYPE "E")

NOTES:
 TIMBER FRAMING MUST COMPLY WITH:
 NZBC B1 STRUCTURES:AS1 CLAUSE 3 TIMBER (NZS 3604:2011)
 NZBC B2 DURABILITY:AS1 CLAUSE 3.2 TIMBER (NZS3602)
 FRAMING DIMENSIONS AND HEIGHT ARE AS DETERMINED BY NZS 3604 STUD AND TOP PLATE TABLES FOR LOAD BEARING AND NON LOAD BEARING WALLS. KILN DRIED VERIFIED STRUCTURAL GRADE TIMBER MUST BE USED. MACHINE GRADED TIMBER SUCH AS LASERFRAME IS RECOMMENDED.
 FASTEN GIB BRACELINE TO FRAME WITH 35mm X 6g GIB GRABBER HIGH THREADED SCREWS AT 50, 100, 150, 225, 300 mm FROM EACH CORNER AND 150mm CENTRES AROUND PERIMETER OF THE BRACING ELEMENT. FOR VERTICALLY FIXED SHEETS PLACE FASTENERS AT 300 CENTRES TO THE SHEET JOINT.
 FIX NEW LINING DIRECTLY TO FRAMING. IF PART OF SHEETS ARE USED ENSURE NAILING AT REQUIRED CENTRES IS CARRIED OUT AROUND THE PERIMETER OF EACH SHEET OR PART SHEET. 2-3mm EXPANSION GAP SHOULD BE LEFT BETWEEN SHEETS.
 FASTEN ECOPLY WITH 50x2.8mm GALVANISED OR STAINLESS STEEL FLAT HEAD NAILS. PLACE FASTENERS NO LESS THAN 7mm FROM SHEET EDGE. FASTENERS ARE PLACED AT 150mm CENTRES AROUND THE PERIMETER OF EACH SHEET AND 300mm CENTRES TO INTERMEDIATE STUDS AND DWANGS. WHERE MORE THAN ONE SHEET FORMS PART OF THE BRACE ELEMENT EACH SHEET MUST BE NAILED OFF INDEPENDENTLY.

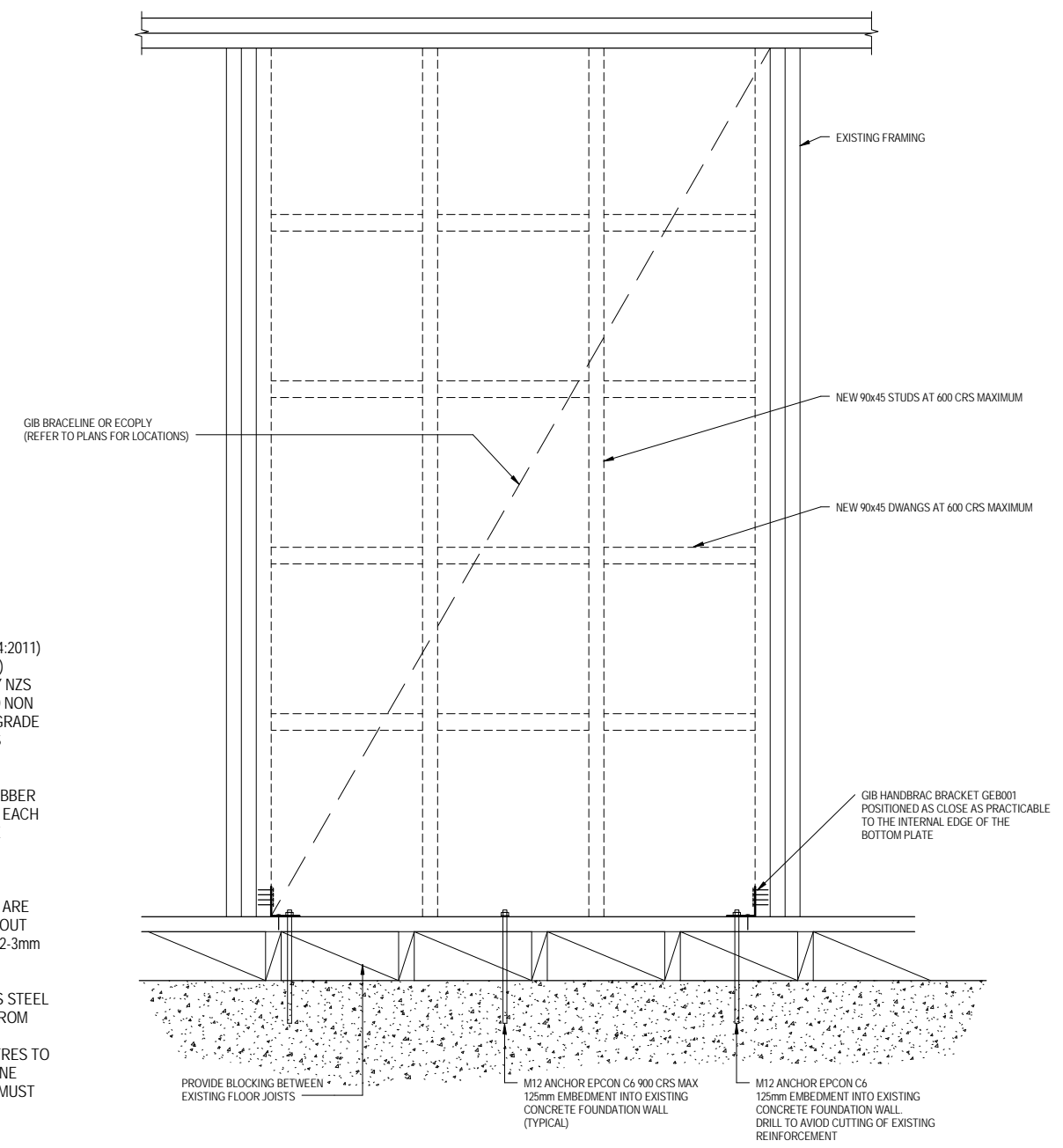

GIB BL1-H, GIB BLG-H, BLP-H, AND ECOPLY EP1 TYPICAL HOLD DOWN DETAIL



REV	DATE	REVISION DETAILS	APPROVAL
A	20/10/15	FOR INFORMATION	J.FINNEGAN

SCALE	SIZE
As indicated	A1

INFORMATION ONLY NOT FOR CONSTRUCTION
APPROVED
J.FINNEGAN
J.FINNEGAN

PROJECT	TITLE
MOE - NATIONWIDE FLS AUCKLAND, WELLINGTON AND CHRISTCHURCH AVALON BLOCK	DETAILS

DRAWING No.	PROJECT No.	WBS	TYPE	DISC - NUMBER	REV
246313	246313	AVALL	DRG	S48-01	A

File Path: C:\Users\jfinnegan\Documents\246313\AVALON BLOCK\CENTRAL FLEETS\05_151015.dwg
 Date: 20/10/2015 13:27:21
 User: jfinnegan